

PE INFEED, CONNECTION MAIN CIRCUIT: SPRING-LOADED TERMINAL, TERMINAL MAX. 25 MM²



General technical data:		
product brandname		SIRIUS
Product designation		PE infeed
Protection class IP		IP20
Degree of pollution		3
Installation altitude at height above sea level maximum	m	2 000
Ambient temperature		
• during transport	°C	-55 ... +80
• during storage	°C	-55 ... +80
• during operation	°C	-20 ... +60
Vibration resistance		f = 4 to 5.8 Hz; d = 15 mm; f = 5.8 to 500 Hz; a = 2 m / s ² 10 cycles
Shock resistance		Semi-sinusoidal a = 6 m/s ² at 10 ms; 3 pos. and 3 neg. Shock in all axes
Equipment marking acc. to DIN EN 61346-2		W
Equipment marking acc. to DIN 40719 extended according to IEC 204-2 acc. to IEC 750		W

Main circuit:

Operating current at AC at 400 V rated value	A	63
--	---	----







Installation/ mounting/ dimensions:

Mounting type		plug-in fixing
Width	mm	32
Height	mm	65
Depth	mm	70

Connections/ Terminals:

Type of electrical connection for main current circuit		spring-loaded terminals
Wire stripping length for main contacts	mm	23
Connectable conductor cross-section for supply for main contacts using the upper clamping point		
• solid	mm ²	4 ... 35
• stranded	mm ²	4 ... 35
• finely stranded with core end processing	mm ²	4 ... 25
• finely stranded without core end processing	mm ²	6 ... 25
AWG number as coded connectable conductor cross section for supply for main contacts		
• using the upper clamping point		10 ... 3
Type of connectable conductor cross-sections for supply for main contacts using the upper clamping point		
• solid		4 ... 35 mm ²
• stranded		4 ... 35 mm ²
• finely stranded with core end processing		4 ... 25 mm ²
• finely stranded without core end processing		6 ... 25 mm ²
Type of connectable conductor cross-sections at AWG conductors for supply for main contacts		
• using the upper clamping point		10 ... 3

Certificates/ approvals:

General Product Approval			EMC	Declaration of Conformity	Shipping Approval
 CSA	 UL		 C-Tick	 EG-Konf.	 BUREAU VERITAS

Shipping Approval					other
 DNV	 LRS	 PRS	 RINA	 RMRS	Environmental Confirmations

other
Confirmation

Safety related data:	
Protection against electrical shock	finger-safe

Further information
Information- and Downloadcenter (Catalogs, Brochures,...) http://www.siemens.com/industrial-controls/catalogs
Industry Mall (Online ordering system) http://www.siemens.com/industrymall
Cax online generator http://support.automation.siemens.com/WW/CAXorder/default.aspx?lang=en&mlfb=3RA6860-5AC
Service&Support (Manuals, Certificates, Characteristics, FAQs,...) https://support.industry.siemens.com/cs/ww/en/ps/3RA6860-5AC
Image database (product images, 2D dimension drawings, 3D models, device circuit diagrams, EPLAN macros, ...) http://www.automation.siemens.com/bilddb/cax_de.aspx?mlfb=3RA6860-5AC&lang=en

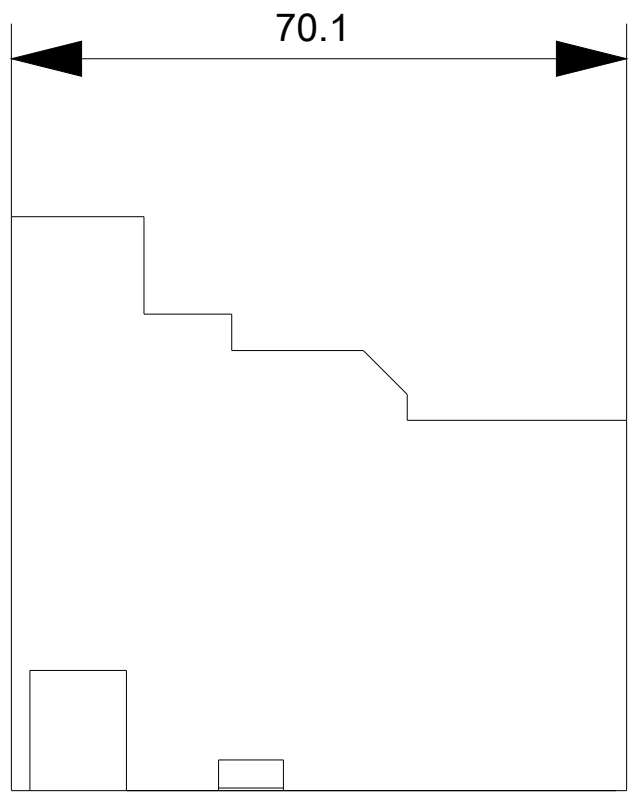
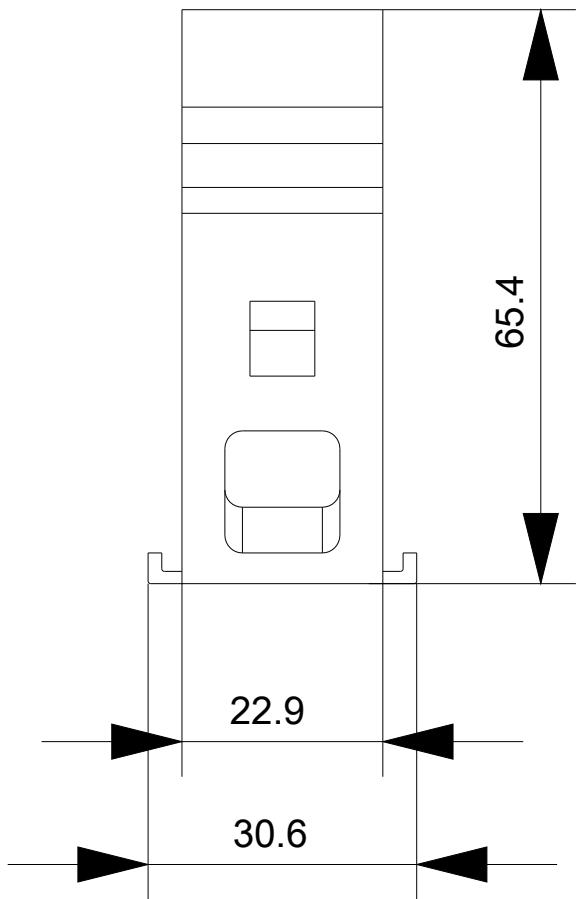

last modified:

07/01/2017